

SPICE thermal model

BUK764R0-40E

Symbol	Parameter	Conditions	Min	Typ	Max	Unit
$R_{th(j-mb)}$	thermal resistance from junction to mounting base		-	-	0.82	K/W

C_{th1}	1.128E-04 F
C_{th2}	8.153E-04 F
C_{th3}	6.066E-04 F
C_{th4}	2.369E-03 F
C_{th5}	6.973E-03 F
C_{th6}	1.600E-02 F
C_{th7}	5.627E-01 F
C_{th8}	5.931E+01 F

R_{th1}	7.791E-04 Ω
R_{th2}	1.532E-03 Ω
R_{th3}	1.801E-02 Ω
R_{th4}	4.374E-02 Ω
R_{th5}	1.604E-01 Ω
R_{th6}	5.174E-01 Ω
R_{th7}	9.637E-02 Ω
R_{th8}	3.222E-03 Ω

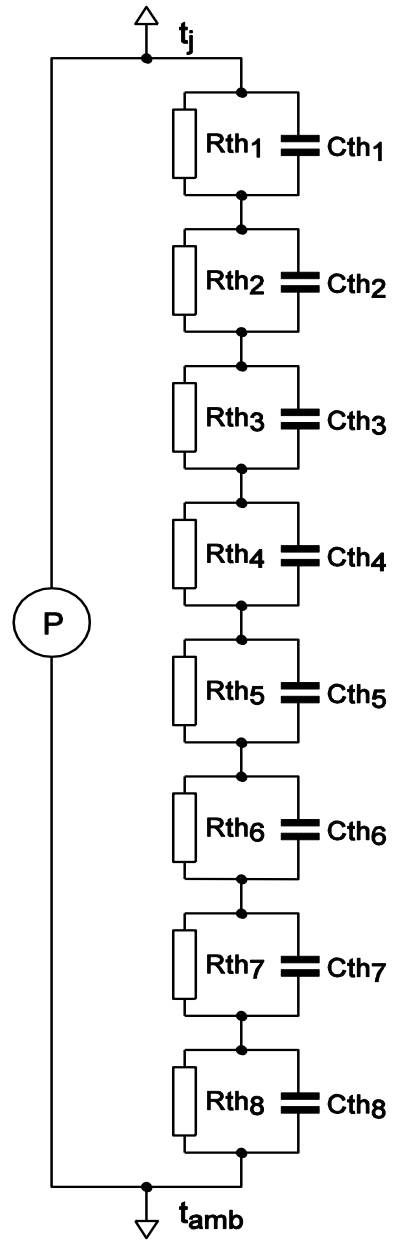

Part: BUK764R0-40E
 Date: 11/4/2013
 Model Rth 0.84 K/W